

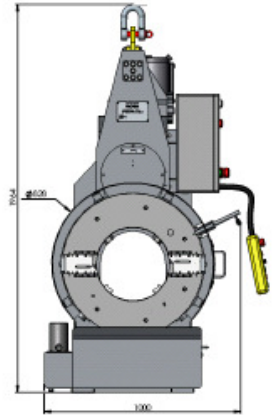

Heavy duty severing and beveling machine TNO 24-36“

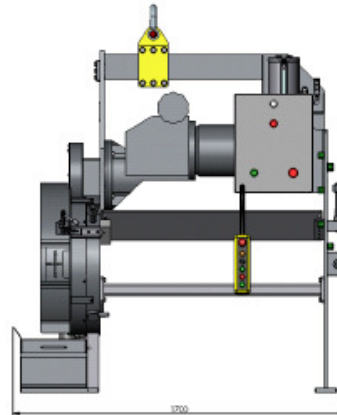

The TNO beveling machines are especially designed to fit your piping or tubing prefab application on site or in workshops. These machines sever and bevel heavy wall pipes faster than any other machine. They allow to save man hours by avoiding grinding operations, flame cutting, difficult handling and setting of pipes on a lathe. They are transportable, rigid, fast and accurate.